

## Screw Joints for HPLC



177

SCREW JOINTS FOR HPLC

Easy handling, sturdy design and pressure resistance up to 30 bar: also in HPLC applications BOLA Screw Joints are your first choice.

### PRODUCT TIPS



Page 178  
Distributors for Bottles



Page 182  
Tubing with mini fittings



Page 181  
Distributors with UNF  
Threads



## BOLA HPLC Distributors for Bottles

They consist of a screw cap made of glass-fibre reinforced PP with GL 45 thread and a movable body with connection ports. All necessary screw joints and gaskets for connecting hard-walled tubing (e.g. PTFE, FEP or PFA) up to a maximum diameter of 6 mm are included in delivery and make the HPLC distributors usable immediately.

Tubing up to a diameter of 4 mm can be passed and fixed absolutely tightly at the requested immersion depth.

The distributors with stopcocks allow closing unused ports; the FEP stopcock plug provides a universal chemical resistance.

Because of the stopcocks, it is not possible to pass the tubing. A connection to the bottom of the bottle can still be made by pushing tubing with O.D. of 5 mm or I.D. of 6 mm in or on the port on the lower side of the distributor.

A possible unevenness of the bottle neck is adjusted by an o-ring behind an elastic sealing lip, and the bottle is closed tightly. The product is only exposed to the body of the distributor.

The special feature: the body of the distributor can be turned independently from the screw cap. This means, that the completely assembled distributor can be removed and fixed on another bottle without the risk of disarranging the tubing.

### BOLA HPLC Distributors for Bottles

**BESTSELLER**

Material:	Temperature resistance:	Chemical resistance:	autoclave:
PP	from -20°C to +140°C	++ very good	121°

#### Product description:

Green screw cap made of glass-fibre reinforced PP for bottle thread GL 45 and body made of PP. Available either with four ports with screw joints suitable for tubing O.D. 1,6 to 2,0 mm and 2,1 to 4,0 mm or with four ports with screw joints suitable for tubing O.D. 6,0 mm. Plugs for closing unused ports are included in delivery.

FDA conform

Suitable for thread GL	Four ports for tubing O.D. mm	Cat. No.:
45	1,6 - 4,0	D 606-08
45	6,0	D 608-08



## BOLA HPLC Distributors for Bottles with Stopcocks

Material: **PP**      Temperature resistance: **from -20°C to + 140°C**      Chemical resistance: **++ very good**      autoclave: **121°**

Product description:

Green screw cap made of glass-fibre reinforced PP for bottle thread GL 45 and body made of PP. With four ports with screw joints suitable for tubing O.D. 1,6 to 2,0 mm and 2,1 to 4,0 mm and four stopcocks with stopcock plugs made of FEP.

FDA conform

Suitable for thread GL	Four ports for tubing O.D. mm	Bore dia. of stopcock mm	Cat. No.:
45	1,6 - 4,0	2,4	D 607-08



179

## BOLA Replacement Parts for HPLC Distributors for Bottles

### BOLA Replacement Nuts

Product description:

Nuts made of PP.

FDA conform

	For tubing O.D. mm	Cat. No.:
<b>A</b>	1,6 - 4,0	D 610-02
	6,0	D 610-04



### BOLA Replacement Sealing Rings

Product description:

Sealing rings made of silicone. Packing unit: 10 pieces

	For tubing O.D. mm	Cat. No.:
<b>B</b>	1,6 - 2,0	D 610-08
	2,1 - 4,0	D 610-12



### Replacement O-Rings

Product description:

O-rings made of FPM. Packing unit: 10 pieces

	For tubing O.D. mm	Cat. No.:
<b>C</b>	6,0	D 610-16

### BOLA Replacement Plugs

Product description:

Plugs made of silicone. Packing unit: 10 pieces

	Cat. No.:
<b>D</b>	D 610-30

### BOLA Extender with Adaptor for Syringe Filters

Product description:

Made of PTFE, with female Luer cone for fixing syringe filters.

FDA conform

A Connection	B O.D. mm	Cat. No.:
Luer cone	3,5	D 610-50



### Applications:

For sterile aeration by means of syringe filters.



## BOLA Screw Joints for HPLC



### What you should know about the BOLA HPLC Screw Joint System

This system is based on flanged tubing and UNF 1/4" 28 G threads. These threads have their origin in the United States and are mainly used in chromatography/HPLC. "1/4"" stands for the outer diameter of 6,35 mm. "28 G" stands for 28 thread pitches at the length of one inch (25,4 mm).

Following tubing sizes are mainly used in HPLC:

- » 1/8" (O.D. approx. 3,2 mm x I.D. approx. 1,6 mm)
- » 1/16" (O.D. approx. 1,6 mm x I.D. approx. 0,8 mm)

The screw joint itself consists of a screw (BOLA Tube End Fitting) with washer and flanged tubing. It resists pressures up to 30 bar.

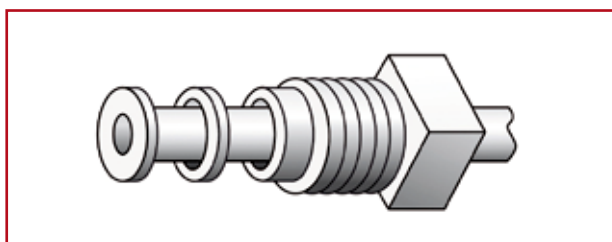

The metal-free washer provides ideal contact pressure of the flanged tubing and prevents small folds during the last phase of tightening the tube end fitting.

The flowing product is only exposed to PTFE – the screw joint has a universal chemical resistance and is absolutely clean.

The PTFE tubing to be flanged must be made of a special type of PTFE. Our tubing fulfils this requirement (see page 198). Besides PTFE tubing, there can also be used FEP and PFA tubing (both gastight and transparent).

The different colours of the tube end fittings can be used for distinction.

### How to flange PTFE tubing

- » cut tubing square
- » clamp tubing by means of tubing holder – overhang approx. 3-5 mm
- » press tubing on flanging tip and preform it
- » press preformed tubing end on cooling plate
- » push fitting and washer on the tubing and tighten the fitting
- » ready



Of course we also have flanged tubing with assembled tube end fittings in different lengths in our standard range (see page 182).

We can also manufacture tubing according to your requirements.

### Don't confuse UNF 1/4" 28 and M6 threads!

Besides the common UNF threads, there are also M6 threads circulating. These threads are very similar to the UNF thread, but please only use UNF tube end fittings to avoid damage or leakage of your fittings. You can find universal couplings for a transition from UNF 1/4" 28G to M6 on page 186.



**BESTSELLER**

**BOLA Distributors for Bottles**

Material: PTFE      Temperature resistance: from -50°C to +200°C      Chemical resistance: +++ universal

Product description:

Black screw cap made of PPS for bottle thread GL 45. Without stopcocks: body made of PTFE with 2 or 4 ports with female thread UNF 1/4" 28 G on upper and lower sides. With stopcocks: body made of PTFE with 2 or 3 ports with female thread UNF 1/4" 28 G on upper and lower sides and stopcock made of FEP for each port. A possible unevenness of the bottle neck is adjusted by an o-ring behind an elastic sealing lip, and the bottle is closed tightly. The product is only exposed to the body of the distributor. The body of the distributor can be turned independently from the screw cap. This means, that the assembled distributor can be removed completely and fixed on another bottle without the risk of disarranging the tubing. Very good chemical resistance, for working temperatures up to +200°C.

FDA conform

	For tubing I.D. x O.D. mm	Bore dia. mm	Connections	Cat. No.:	
<b>A</b>	0,8 x 1,6	0,8	2 x UNF 1/4" 28G	F 745-02	
<b>B</b>	0,8 x 1,6	0,8	4 x UNF 1/4" 28G	F 745-10	
	For tubing I.D. x O.D. mm	Bore dia. mm	Connections	Cat. No.:	
<b>A</b>	1,6 x 3,2	1,6	2 x UNF 1/4" 28G	F 745-04	
<b>B</b>	1,6 x 3,2	1,6	4 x UNF 1/4" 28G	F 745-12	
	For tubing I.D. x O.D. mm	Number of stopcocks	Bore dia. mm	Connections	Cat. No.:
<b>C</b>	0,8 x 1,6	2	0,8	2 x UNF 1/4" 28G	F 746-02
<b>D</b>	0,8 x 1,6	3	0,8	3 x UNF 1/4" 28G	F 746-10
	For tubing I.D. x O.D. mm	Number of stopcocks	Bore dia. mm	Connections	Cat. No.:
<b>C</b>	1,6 x 3,2	2	1,6	2 x UNF 1/4" 28G	F 746-04
<b>D</b>	1,6 x 3,2	3	1,6	3 x UNF 1/4" 28G	F 746-12

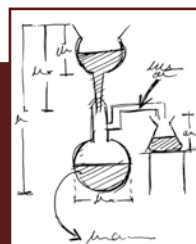
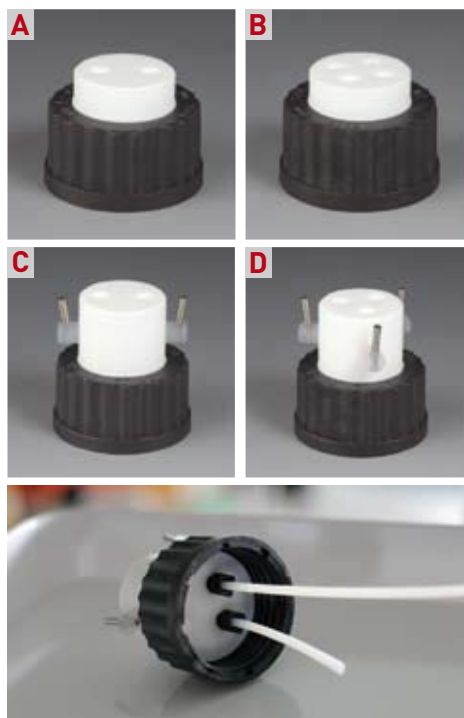

Products to your specification – simply send us a sketch.

As a manufacturing company, we can also make products to your specification.

Simply send us a sketch by fax or e-mail. We will be glad to send you a free, no obligation quotation.

Fax: +49 (0)9346/9286-55 >> E-Mail: inquiry@bola.de

## BOLA Chromatography Adaptors

Material: **PTFE**      Temperature resistance: **from -50°C to +200°C**      Chemical resistance: **+++ universal**

### Product description:

Black screw made of PPS with GL thread. Body made of PTFE with one port with female thread UNF 1/4" 28 G for connection of mini fittings (see tube end fittings page 182). A possible unevenness of the bottle neck is adjusted by an o-ring behind an elastic sealing lip, and the bottle is closed tightly. The product is only exposed to the body of the adaptor. Very good chemical resistance, for working temperatures up to max. +200°C.

FDA conform

Thread of screw cap GL	For tubing I.D. x O.D. mm	Cat. No.:
14	(1/32" x 1/16") 0,8 x 1,6	F 755-03
18	(1/32" x 1/16") 0,8 x 1,6	F 755-06
25	(1/32" x 1/16") 0,8 x 1,6	F 755-09
32	(1/32" x 1/16") 0,8 x 1,6	F 755-12
45	(1/32" x 1/16") 0,8 x 1,6	F 755-15

Thread of screw cap GL	For tubing I.D. x O.D. mm	Cat. No.:
14	(1/16" x 1/8") 1,6 x 3,2	F 757-03
18	(1/16" x 1/8") 1,6 x 3,2	F 757-06
25	(1/16" x 1/8") 1,6 x 3,2	F 757-09
32	(1/16" x 1/8") 1,6 x 3,2	F 757-12
45	(1/16" x 1/8") 1,6 x 3,2	F 757-15



## BOLA Flanged Tubing

**BESTSELLER**

Material: **PTFE**      Temperature resistance: **from -50°C to +120°C**      Chemical resistance: **+++ universal**      Pressure: **30 bar**

### Product description:

Flanged PTFE tubing with black tube end fittings UNF 1/4" 28 G made of PP and washers made of PA. The tubing is ready for use.



FDA conform

Tubing I.D. x O.D. mm	Total length mm	Cat. No.:
(1/32" x 1/16") 0,8 x 1,6	100	F 740-02
(1/32" x 1/16") 0,8 x 1,6	250	F 740-04
(1/32" x 1/16") 0,8 x 1,6	500	F 740-06
(1/32" x 1/16") 0,8 x 1,6	750	F 740-08
(1/32" x 1/16") 0,8 x 1,6	1.000	F 740-10

Tubing I.D. x O.D. mm	Total length mm	Cat. No.:
(1/16" x 1/8") 1,6 x 3,2	100	F 740-20
(1/16" x 1/8") 1,6 x 3,2	250	F 740-22
(1/16" x 1/8") 1,6 x 3,2	500	F 740-24
(1/16" x 1/8") 1,6 x 3,2	750	F 740-26
(1/16" x 1/8") 1,6 x 3,2	1.000	F 740-28

### Applications:

Connection to BOLA Distributors for Bottles or BOLA Chromatography Adaptors.



## BOLA Miniature Couplings

Material: PTFE    Material: POM    Temperature resistance: from -200°C to +200°C    Chemical resistance: +++ universal

Product description:

Three types of couplings available: straight type made of PTFE or POM with higher mechanical strength, "T" type with three connections or "cross" type with four connections, all made of PTFE. The tubing is connected by means of tube end fittings (see page 182) to a female thread UNF 1/4" 28 G.

FDA conform

	Type	Material	For tubing I.D x O.D. mm	Connections	Total length mm	Cat. No.:
<b>A</b>	straight	POM	(1/32" x 1/16") 0,8 x 1,6	2	17	F 707-02
<b>B</b>	straight	PTFE	(1/32" x 1/16") 0,8 x 1,6	2	17	F 707-06
<b>C</b>	T	PTFE	(1/32" x 1/16") 0,8 x 1,6	3	25	F 707-14
<b>D</b>	+	PTFE	(1/32" x 1/16") 0,8 x 1,6	4	25	F 707-18

	Type	Material	For tubing I.D x O.D. mm	Connections	Total length mm	Cat. No.:
<b>A</b>	straight	POM	(1/16" x 1/8") 1,6 x 3,2	2	17	F 707-04
<b>B</b>	straight	PTFE	(1/16" x 1/8") 1,6 x 3,2	2	17	F 707-08
<b>C</b>	T	PTFE	(1/16" x 1/8") 1,6 x 3,2	3	25	F 707-16
<b>D</b>	+	PTFE	(1/16" x 1/8") 1,6 x 3,2	4	25	F 707-20

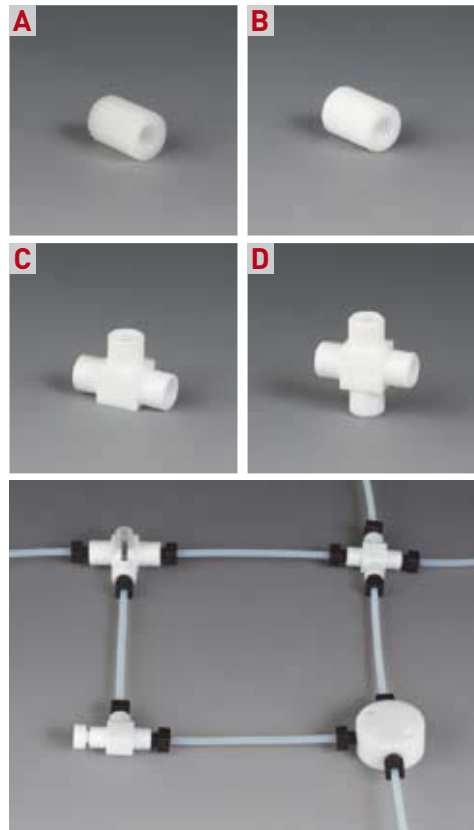

## BOLA Miniature Distributors

Material: PTFE    Temperature resistance: from -200°C to +200°C    Chemical resistance: +++ universal    Pressure: 30 bar

Product description:

Blocks with up to nine connections. The tubing is connected by means of tube end fittings (see page 182) to a female thread UNF 1/4" 28 G. With two mounting holes dia. 3,5 mm for fixing.

FDA conform

	For tubing I.D. x O.D. mm	Connections	O.D. mm	Height mm	Cat. No.:
<b>A</b>	(1/32" x 1/16") 0,8 x 1,6	3	28	15	F 710-01
<b>B</b>	(1/32" x 1/16") 0,8 x 1,6	4	28	15	F 710-05
<b>C</b>	(1/32" x 1/16") 0,8 x 1,6	9	28	36	F 710-09

	For tubing I.D. x O.D. mm	Connections	O.D. mm	Height mm	Cat. No.:
<b>A</b>	(1/16" x 1/8") 1,6 x 3,2	3	28	15	F 710-03
<b>B</b>	(1/16" x 1/8") 1,6 x 3,2	4	28	15	F 710-07
<b>C</b>	(1/16" x 1/8") 1,6 x 3,2	9	28	36	F 710-11

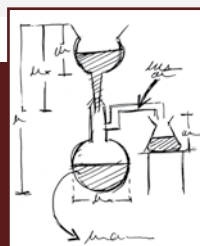
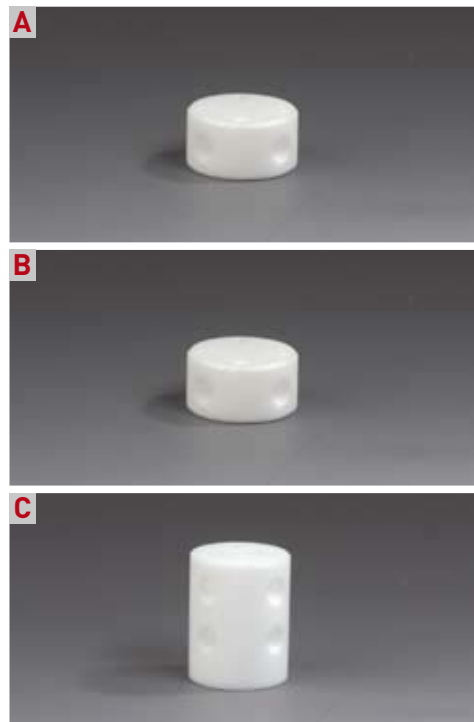

Products to your specification – simply send us a sketch.

As a manufacturing company, we can also make products to your specification.

Simply send us a sketch by fax or e-mail. We will be glad to send you a free, no obligation quotation.

Fax: +49 (0)9346/9286-55 >> E-Mail: inquiry@bola.de

## BOLA Miniature 2-Way Stopcocks

Material: <b>PTFE</b>	Temperature resistance: <b>from -10°C to +120°C</b>	Chemical resistance: <b>+++ universal</b>	Pressure: <b>8 bar</b>
--------------------------	--	--	---------------------------

Product description:

2-way stopcock with straight bore and two connections. Available either with two female threads UNF 1/4" 28 G or with one female thread UNF 1/4" 28 G and one male thread UNF 1/4" 28 G. Total height including stopcock plug made of FEP: 20 mm.

FDA conform

	For tubing I.D. x O.D. mm	Connections female thread	Connections male thread	Total length mm	Cat. No.:
<b>A</b>	(1/32" x 1/16") 0,8 x 1,6	2		32	<b>F 730-02</b>
<b>B</b>	(1/32" x 1/16") 0,8 x 1,6	1	1	35	<b>F 730-06</b>

	For tubing I.D. x O.D. mm	Connections female thread	Connections male thread	Total length mm	Cat. No.:
<b>A</b>	(1/16" x 1/8") 1,6 x 3,2	2		32	<b>F 730-04</b>
<b>B</b>	(1/16" x 1/8") 1,6 x 3,2	1	1	35	<b>F 730-08</b>

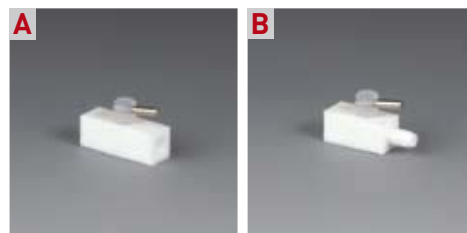

## BOLA Miniature 3-Way Stopcocks

Material: <b>PTFE</b>	Temperature resistance: <b>from -10°C to +120°C</b>	Chemical resistance: <b>+++ universal</b>	Pressure: <b>8 bar</b>
--------------------------	--	--	---------------------------

Product description:

3-way stopcock with "L"-shaped or "T"-shaped bore and three connections. Available either with three female threads UNF 1/4" 28 G or with two female threads UNF 1/4" 28 G and one male thread UNF 1/4" 28 G. Total height including stopcock plug made of FEP: 20 mm.

FDA conform

	For tubing I.D. x O.D. mm	Connections female thread	Connections male thread	Bore shape of stopcock	Total length mm	Cat. No.:
<b>A</b>	(1/32" x 1/16") 0,8 x 1,6	3		L	32	<b>F 731-02</b>
	(1/32" x 1/16") 0,8 x 1,6	3		T	32	<b>F 731-06</b>
<b>B</b>	(1/32" x 1/16") 0,8 x 1,6	2	1	L	42	<b>F 731-10</b>
	(1/32" x 1/16") 0,8 x 1,6	2	1	T	42	<b>F 731-14</b>

	For tubing I.D. x O.D. mm	Connections female thread	Connections male thread	Bore shape of stopcock	Total length mm	Cat. No.:
<b>A</b>	(1/16" x 1/8") 1,6 x 3,2	3		L	32	<b>F 731-04</b>
	(1/16" x 1/8") 1,6 x 3,2	3		T	32	<b>F 731-08</b>
<b>B</b>	(1/16" x 1/8") 1,6 x 3,2	2	1	L	42	<b>F 731-12</b>
	(1/16" x 1/8") 1,6 x 3,2	2	1	T	42	<b>F 731-16</b>

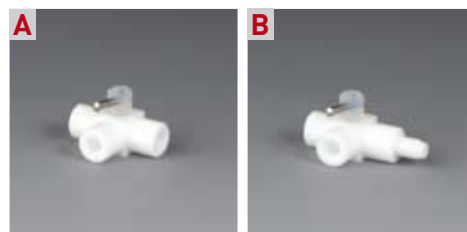



## BOLA Miniature Manifold Blocks

Material: PTFE    Temperature resistance: from -10°C to +120°C    Chemical resistance: +++ universal    Pressure: 8 bar

Product description:

Block made of PTFE with one inlet and four outlets with female thread UNF 1/4" 28 G. Also available with four stopcocks with stopcock plugs made of FEP for easy interruption and control of flow. Suitable flanged tubing can be found on page 182.

FDA conform

	For tubing I.D. x O.D. mm	Number of stopcocks	Bore dia. mm	Inlet	Outlet	Cat. No.:
<b>A</b>	(1/32" x 1/16") 0,8 x 1,6		0,8	1	4	F 712-01
<b>B</b>	(1/32" x 1/16") 0,8 x 1,6	4	0,8	1	4	F 712-10

	For tubing I.D. x O.D. mm	Number of stopcocks	Bore dia. mm	Inlet	Outlet	Cat. No.:
<b>A</b>	(1/16" x 1/8") 1,6 x 3,2		1,6	1	4	F 712-03
<b>B</b>	(1/16" x 1/8") 1,6 x 3,2	4	1,6	1	4	F 712-12



## BOLA Miniature Pressure Relief Valves

Material: PTFE    Temperature resistance: from -20°C to +150°C    Chemical resistance: +++ universal    Pressure: 5 bar

Product description:

Body made of PTFE with two connections with female thread UNF 1/4" 28 G. Valve made of PPS with set screw and lock nut for adjusting and fixing pressure between 0,1 and 5 bar (factory setting 1,5 bar). Suitable flanged tubing can be found on page 182.

NEW

FDA conform

	For tubing I.D. x O.D. mm	O.D. mm	Total height mm	Cat. No.:
	(1/32" x 1/16") 0,8 x 1,6	32	50	F 738-08

	For tubing I.D. x O.D. mm	O.D. mm	Total height mm	Cat. No.:
	(1/16" x 1/8") 1,6 x 3,2	32	50	F 738-16

**Product advantages:**

- » low dead volume
- » flow direction is marked by an arrow
- » two holes for panel mounting
- » universal chemical resistance, the flowing product is only exposed to PTFE

**Applications:**

Pressure control valve with adjustable opening pressure. For preventing pressure drop during filling.

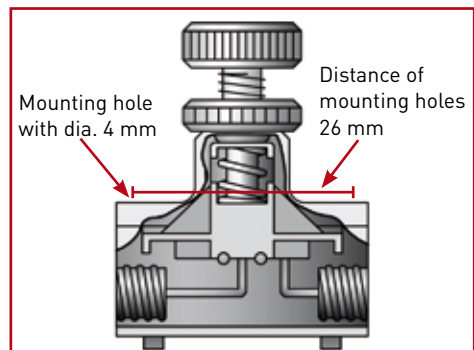

## BOLA Universal Couplings

Material: **PTFE** Temperature resistance: **from -200°C to +250°C** Chemical resistance: **+++ universal**

Product description:

Coupling made of PTFE for transition from M6 thread to UNF 1/4" 28 G thread. The M6 thread is marked by a groove.

FDA conform

	Female thread	Female thread	Bore dia. mm	Cat. No.:
<b>A</b>	M 6	UNF 1/4" 28 G	0,8	<b>F 770-08</b>

	Male thread	Male thread	Bore dia. mm	Cat. No.:
<b>B</b>	M 6	UNF 1/4" 28 G	0,8	<b>F 772-08</b>

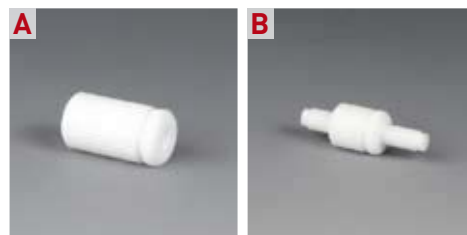

## BOLA Miniature Screw-in Adaptors

Material: **PTFE** Temperature resistance: **from -200°C to +250°C** Chemical resistance: **+++ universal**

Product description:

Adaptor made of PTFE for transition from female thread UNF 1/4" 28 G to male thread NPT 1/8" or NPT 1/4"

FDA conform

For tubing I.D. x O.D. mm	Female thread	Male thread	Bore dia. mm	Cat. No.:
(1/32" x 1/16") 0,8 x 1,6	UNF 1/4" 28 G	NPT 1/8"	0,8	<b>F 716-02</b>
(1/32" x 1/16") 0,8 x 1,6	UNF 1/4" 28 G	NPT 1/4"	0,8	<b>F 716-06</b>

For tubing I.D. x O.D. mm	Female thread	Male thread	Bore dia. mm	Cat. No.:
(1/32" x 1/16") 1,6 x 3,2	UNF 1/4" 28 G	NPT 1/8"	1,6	<b>F 716-04</b>
(1/32" x 1/16") 1,6 x 3,2	UNF 1/4" 28 G	NPT 1/4"	1,6	<b>F 716-08</b>



## BOLA Miniature Luer Connectors

Material: **PTFE** Temperature resistance: **from -200°C to +250°C** Chemical resistance: **+++ universal**

Product description:

Connector made of PTFE for transition from Luer connection to female thread UNF 1/4" 28 G

FDA conform

For tubing I.D. x O.D. mm	Female thread	Luer cone	Bore dia. mm	Cat. No.:
<b>A</b> (1/32" x 1/16") 0,8 x 1,6	UNF 1/4" 28 G	female	1,0	<b>F 717-02</b>
<b>B</b> (1/32" x 1/16") 0,8 x 1,6	UNF 1/4" 28 G	male	1,0	<b>F 717-06</b>

For tubing I.D. x O.D. mm	Female thread	Luer cone	Bore dia. mm	Cat. No.:
<b>A</b> (1/16" x 1/8") 1,6 x 3,2	UNF 1/4" 28 G	female	1,6	<b>F 717-04</b>
<b>B</b> (1/16" x 1/8") 1,6 x 3,2	UNF 1/4" 28 G	male	1,6	<b>F 717-08</b>

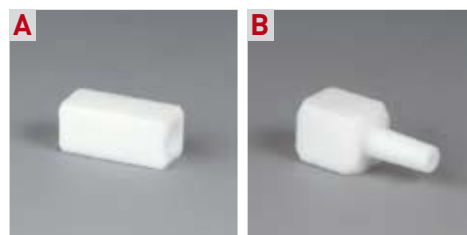

**BOLA Tube End Fittings**

Material: **PTFE**      Temperature resistance: **from -200°C to +260°C**      Chemical resistance: **+++ universal**

Product description:

White tube end fittings made of PTFE. With male thread UNF 1/4" 28 G; washers made of PA are included in delivery. Packing unit: 10 pieces, differing ordering quantities are rounded up to factor 10.



FDA conform

For tubing I.D. x O.D. mm	Colour	Cat. No.:
(1/32" x 1/16") 0,8 x 1,6	white	F 702-02

For tubing I.D. x O.D. mm	Colour	Cat. No.:
(1/16" x 1/8") 1,6 x 3,2	white	F 702-04



Material: **PP**      Temperature resistance: **from -10°C to +100°C**      Chemical resistance: **++ very good**

Product description:

Coloured tube end fittings made of PP. With male thread UNF 1/4" 28 G; washers made of PA are included in delivery. Packing unit: 10 pieces, differing ordering quantities are rounded up to factor 10.



For tubing I.D. x O.D. mm	Colour	Cat. No.:
(1/32" x 1/16") 0,8 x 1,6	natural (white)	F 702-06
(1/32" x 1/16") 0,8 x 1,6	black	F 702-10
(1/32" x 1/16") 0,8 x 1,6	red	F 702-18
(1/32" x 1/16") 0,8 x 1,6	orange	F 702-22
(1/32" x 1/16") 0,8 x 1,6	yellow	F 702-26
(1/32" x 1/16") 0,8 x 1,6	green	F 702-30
(1/32" x 1/16") 0,8 x 1,6	blue	F 702-34
(1/32" x 1/16") 0,8 x 1,6	violet	F 702-38
(1/32" x 1/16") 0,8 x 1,6	grey	F 702-42

For tubing I.D. x O.D. mm	Colour	Cat. No.:
(1/16" x 1/8") 1,6 x 3,2	natural (white)	F 702-08
(1/16" x 1/8") 1,6 x 3,2	black	F 702-12
(1/16" x 1/8") 1,6 x 3,2	red	F 702-20
(1/16" x 1/8") 1,6 x 3,2	orange	F 702-24
(1/16" x 1/8") 1,6 x 3,2	yellow	F 702-28
(1/16" x 1/8") 1,6 x 3,2	green	F 702-32
(1/16" x 1/8") 1,6 x 3,2	blue	F 702-36
(1/16" x 1/8") 1,6 x 3,2	violet	F 702-40
(1/16" x 1/8") 1,6 x 3,2	grey	F 702-44

**Applications:**

Different colours for better distinction.



**SUITABLE:** page 189  
Tubing for all screw joints



## BOLA Double Tube End Fittings

Material: **PTFE** Temperature resistance: **from -200°C to +260°C** Chemical resistance: **+++ universal**

Product description:

Made of PTFE, with two male threads UNF 1/4" 28 G. Packing unit: 10 pieces, differing ordering quantities are rounded up to factor 10.

FDA conform

For tubing I.D. x O.D. mm	Colour	Cat. No.:
(1/32" x 1/16") 0,8 x 1,6	white	F 703-02
For tubing I.D. x O.D. mm	Colour	Cat. No.:
(1/16" x 1/8") 1,6 x 3,2	white	F 703-04



## BOLA Plugs

Material: **PTFE** Temperature resistance: **from -200°C to +260°C** Chemical resistance: **+++ universal**

Product description:

Made of PTFE. For closing unused ports of miniature fittings. With male thread UNF 1/4" 28 G. Packing unit: 10 pieces, differing ordering quantities are rounded up to factor 10.

FDA conform

For tubing I.D. x O.D. mm	Colour	Cat. No.:
(1/32" x 1/16") 0,8 x 1,6	white	F 705-02
For tubing I.D. x O.D. mm	Colour	Cat. No.:
(1/16" x 1/8") 1,6 x 3,2	white	F 705-04



## BOLA Washers

Material: **PA** Temperature resistance: **from -10°C to +100°C**

Product description:

Made of PA. For stabilising the flange and avoiding damages when tightening the tube end fitting. Packing unit: 10 pieces, differing ordering quantities are rounded up to factor 10.

FDA conform

For tubing I.D. x O.D. mm	Cat. No.:
(1/32" x 1/16") 0,8 x 1,6	F 728-08
For tubing I.D. x O.D. mm	Cat. No.:
(1/16" x 1/8") 1,6 x 3,2	F 728-16

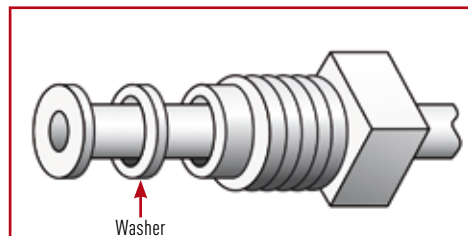

## BOLA Assortments of Tube End Fittings

Material: **PP**      Temperature resistance: **from -10°C to +100°C**      Chemical resistance: **++ very good**

### Product description:

Tube end fittings made of PP in 9 different colours, two fittings per colour. With male thread UNF 1/4" 28 G; washers made of PA are included in delivery.

Colours: natural, black, orange, yellow, green, blue, violet and grey

Dimensions I.D. x O.D. mm	Cat. No.:
(1/32" x 1/16") 0,8 x 1,6	F 704-02

Dimensions I.D. x O.D. mm	Cat. No.:
(1/16" x 1/8") 1,6 x 3,2	F 704-04

### Applications:

Different colours for better distinction.



189

## BOLA Tubing

### Product description:

Tubing especially suitable for making flanges with BOLA Thermoelectric Flanging Tool (see page 190).

Choose suitable tubing for your application:

- » PTFE: competitive standard tubing in laboratories, transparent to milky white colour, working temperature range between -200°C and +260°C, universal chemical resistance
- » PFA: transparent, non-porous and gastight tubing, wide temperature range between -270°C and +260°C, universal chemical resistance
- » FEP: transparent, non-porous and gastight tubing, working temperature range between -270°C and +205°C, universal chemical resistance

FDA conform

Dimensions I.D. x O.D. mm	Cat. No.:	Cat. No.:	Cat. No.:
	PTFE -Tubing	PFA -Tubing	FEP -Tubing
0,5 x 1,6	S 1810-09		
(1/32" x 1/16") 0,8 x 1,6	S 1810-10	S 1811-02	S 1815-04
1,6 x 2,4	S 1810-24		
(1/16" x 1/8") 1,6 x 3,2	S 1810-26	S 1811-04	S 1815-08
2,4 x 3,2	S 1810-33		



**SUITABLE:** page 110  
Tubing for all screw joints

## BOLA Thermoelectric Flanging Tools

Product description:

For making flanges at the ends of plastic tubing (e.g. PTFE, PFA or FEP)

Following sets are available:	For tubing I.D. mm	Version	Cat. No.:
1 x Basic flanging tool 230V/50 Hz 1 x Exchangeable flanging tip for flanging tubing I.D. 0,8 mm 1 x Tubing holder for tubing O.D. 1,6 mm (1/16") and 3,2 mm (1/8")	0,8	230 V 50 HZ	F 701-02
1 x Basic flanging tool 230V/50 Hz 1 x Exchangeable flanging tip for flanging tubing I.D. 1,6 mm 1 x Tubing holder for tubing O.D. 1,6 mm (1/16") and 3,2 mm (1/8")	1,6	230 V 50 HZ	F 701-04
1 x Basic flanging tool 150V/60 Hz 1 x Exchangeable flanging tip for flanging tubing I.D. 0,8 mm 1 x Tubing holder for tubing O.D. 1,6 mm (1/16") and 3,2 mm (1/8")	0,8	115 V 60 HZ	F 708-02
1 x Basic flanging tool 150V/60 Hz 1 x Exchangeable flanging tip for flanging tubing I.D. 1,6 mm 1 x Tubing holder for tubing O.D. 1,6 mm (1/16") and 3,2 mm (1/8")	1,6	115 V 60 HZ	F 708-04



## BOLA Tubing Holders

Product description:

For tubing with O.D. 1,6 mm (1/16") and 3,2 mm (1/8").

For tubing O.D. mm	Cat. No.:
(1/16") 1,6 and (1/8") 3,2	F 706-06

**Product advantages:**

- » safe fixing of the tubing during the flanging procedure
- » easy assembly and handling
- » injuries due to the hot flanging tips are avoided



## BOLA Flanging Tips

Product description:

For flanging different inner diameters of tubing, suitable for BOLA Thermoelectric Flanging Tools on page 190.

For tubing I.D. mm	Cat. No.:
0,5	F 701-50
(1/32") 0,8	F 701-52
(1/16") 1,6	F 701-54
2,4	F 701-56



## BOLA Standard Construction Kits

Product description:

For making flanges at the ends of plastic tubing (e.g. PTFE, PFA or FEP)

Following sets are available	For tubing I.D. mm	Version	Cat. No.:
1 x BOLA Thermoelectric Flanging Tool with exchangeable flanging tip for tubing I.D. 0,8 mm 1 x BOLA Tube End Fitting Set 5 x BOLA Plugs 10 x BOLA Miniature Couplings (straight) 2 x Miniature Couplings (T) 1 x BOLA Miniature Coupling (cross) 1 x 10 metres of PTFE tubing (I.D. 0,8 mm, O.D. 1,6 mm)	0,8	230 V 50 HZ	<b>F 700-02</b>
1 x BOLA Thermoelectric Flanging Tool with exchangeable flanging tip for tubing I.D. 1,6 mm 1 x BOLA Tube End Fitting Set 5 x BOLA Plugs 10 x BOLA Miniature Couplings (straight) 2 x BOLA Miniature Couplings (T) 1 x BOLA Miniature Coupling (cross) 1 x 10 metres of PTFE tubing (I.D. 1,6 mm x O.D. 3,2 mm)	1,6	230 V 50 HZ	<b>F 700-04</b>



191

SCREW JOINTS FOR HPLC

## BOLA Transition Fittings

Material:	Temperature resistance:	Chemical resistance:	Pressure:
<b>PTFE</b>	<b>from -20°C to +120°C</b>	<b>+++ universal</b>	<b>5 bar</b>

Product description:

Fitting made of PTFE. One side with metric thread and connecting nut with compression rings for connecting tubing or tubes with O.D. 4, 6, 8 or 10 mm. Other side with female thread UNF 1/4" 28 G for connecting flanged tubing with O.D. 1,6 or 3,2 mm by means of tube end fittings.

FDA conform

From tubing I.D. x O.D. mm	To tubing I.D. x O.D. mm	O.D. mm	Total length mm	Cat. No.:
(1/32" x 1/16") 0,8 x 1,6	4 and 6	21	40	<b>F 760-04</b>
(1/32" x 1/16") 0,8 x 1,6	8 and 10	26	46	<b>F 760-14</b>
From tubing I.D. x O.D. mm	To tubing I.D. x O.D. mm	O.D. mm	Total length mm	Cat. No.:
(1/16" x 1/8") 1,6 x 3,2	4 and 6	21	40	<b>F 760-08</b>
(1/16" x 1/8") 1,6 x 3,2	8 and 10	26	46	<b>F 760-18</b>



## BOLA Joining Fittings

Material:	Temperature resistance:	Chemical resistance:	Pressure:	Vacuum:
PTFE	from -20°C to +120°C	+++ universal	5 bar	suitable

Product description:

Fitting made of PTFE. One side with connecting nut with compression rings for connecting tubing or tubes with O.D. 4, 6, 8 or 10 mm. Other side with laboratory screw joint for connecting tubing with O.D. 1,6 or 3,2 mm.

FDA conform

From tubing I.D. x O.D. mm	To tubing I.D. x O.D. mm	O.D. mm	Total length mm	Cat. No.:
(1/32" x 1/16") 0,8 x 1,6	4 and 6	25	76	F 762-04
(1/32" x 1/16") 0,8 x 1,6	8 and 10	25	76	F 762-08

From tubing I.D. x O.D. mm	To tubing I.D. x O.D. mm	O.D. mm	Total length mm	Cat. No.:
(1/16" x 1/8") 1,6 x 3,2	4 and 6	25	74	F 762-14
(1/16" x 1/8") 1,6 x 3,2	8 and 10	25	74	F 762-18



## BOLA HT Laboratory Screw Joints

Material:	Temperature resistance:	Chemical resistance:	Pressure:	Vacuum:
PPS	from -50°C to +250°C	+++ universal	15 bar	suitable

Product description:

Black screw cap made of PPS, inner parts consisting of a v-ring (PPS), a tapered ring and a sealing ring (both PTFE) as well as an o-ring (not exposed to the medium). Good chemical resistance, suitable for temperatures from -50°C to +250°C.

FDA conform

For tubing O.D. mm	Thread M 8 Cat. No.:	Thread M 10 Cat. No.:
(1/16") 1,6	D 662-16	D 664-16
3,0		D 664-30
(1/8") 3,2		D 664-32

**Applications:**

Connecting equipment and fittings with metric threads with hard-walled tubing or tubes made of glass, plastic or metal.

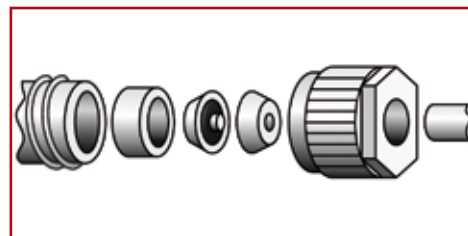



## BOLA Replacement Inner Parts for HT Laboratory Screw Joints

Material: <b>PPS</b>	Temperature resistance: <b>from -50°C to +250°C</b>	Chemical resistance: <b>+++ universal</b>	Pressure: <b>15 bar</b>	Vacuum: <b>suitable</b>
-------------------------	--	--	----------------------------	----------------------------

**Product description:**

Consisting of a v-ring (PPS), a tapered ring and a sealing ring (both PTFE) as well as an o-ring (not exposed to the medium). Good chemical resistance, suitable for temperatures from -50°C to +250°C.

FDA conform

For tubing O.D. mm	Thread M 8 Cat. No.:	Thread M 10 Cat. No.:
(1/16") 1,6	<b>D 672-16</b>	<b>D 674-16</b>
3,0		<b>D 674-30</b>
(1/8") 3,2		<b>D 674-32</b>

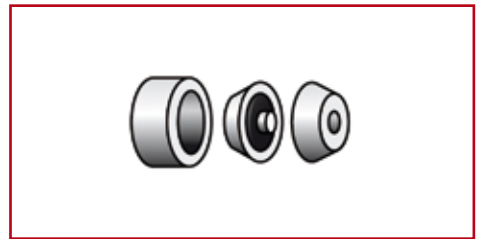

## BOLA Replacement Caps for HT Laboratory Screw Joints

Material: <b>PPS</b>	Temperature resistance: <b>from -50°C to +250°C</b>	Chemical resistance: <b>+++ universal</b>	Pressure: <b>15 bar</b>	Vacuum: <b>suitable</b>
-------------------------	--	--	----------------------------	----------------------------

**Product description:**

Black screw cap made of glass-fibre reinforced PPS, with handy knurl and hexagon. Good chemical resistance, suitable for temperatures from -50°C to +250°C.

FDA conform

For thread	O.D. mm	Length mm	Cat. No.:
M 8	12	19	<b>D 670-08</b>
M 10	14	25	<b>D 670-10</b>



**SUITABLE:** page 110  
Different tubing for all screw joints

## BOLA Connection Bolts

Material: <b>PEEK</b>	Chemical resistance: <b>++ very good</b>	Pressure: <b>280 bar</b>
--------------------------	---	-----------------------------

**Product description:**

Connection bolt and sealing cone made of PEEK, suitable for female thread UNF 10-32 G. Exchangeable sealing cone available separately (Cat. No. F 834-10 on page 194), knurled nut reusable. Suitable for pressures up to max. 280 bar

FDA conform

For tubing/tube O.D. mm	Cat. No.:
(1/16") 1,6	<b>F 833-10</b>



## BOLA Sealing Cones for Connection Bolts

Product description:

Replacement sealing cone made of PEEK, suitable for connection bolts  
Cat. No. F 833-10 on page 193.

FDA conform

For tubing/tube O.D. mm	Cat. No.:
(1/16") 1,6	F 834-10



## BOLA Connection Bolts

Material: PEEK  
Chemical resistance: ++ very good  
Pressure: 450 bar

Product description:

Connection bolt and sealing cone made of PEEK, suitable for female  
thread UNF 10-32G. Suitable for pressures up to max. 450 bar.

FDA conform

For tubing/tube O.D. mm	Cat. No.:
(1/16") 1,6	F 830-10



## BOLA Connection Bolts

Material: PEEK  
Chemical resistance: ++ very good  
Pressure: 400 bar

Product description:

Hexagonal connection bolt and double sided sealing cone made of PEEK,  
suitable for female thread UNF 10-32G. Exchangeable sealing cone  
available separately (Cat. No. F 837-10). Hexagonal nut reuseable. Suitable  
for pressures of up to max. 400 bar.

FDA conform

For tubing/tube O.D. mm	Cat. No.:
(1/16") 1,6	F 836-10



## BOLA Double Sealing Cones for Connection Bolts

Product description:

Replacement double sided sealing cone made of PEEK, suitable for  
connection bolts Cat. No. F 836-10.

FDA conform

For tubing/tube O.D. mm	Cat. No.:
(1/16") 1,6	F 837-10

